



ISSN: 2350-0328

**International Journal of Advanced Research in Science,
Engineering and Technology**

Vol. 7, Issue 11, November 2020

Force Studies a Different Type of Tooth Sampling Drum on a Fiber in a Tape.

OtabekMirzayev,ShavkatBehbudov, HakimboyRaximov, MijgonaShodmonova

Doctor of PhD, senior lecturer of department “General technical disciplines”, Karshi Engineering Economic Institute, Karshi, Uzbekistan.

Doctor of PhD, associate professor of department “Light industry machinery and equipment”, Bukhara Engineering-Technological Institute, Bukhara, Uzbekistan.

Assistant of department “Spinning technology and design”, Bukhara Engineering- Technological Institute, Bukhara, Uzbekistan.

Assistant teacher of department “Light industry machinery and equipment”, Bukhara Engineering- Technological Institute, Bukhara, Uzbekistan.

ABSTRACT: The article provides a theoretical analysis of the state of a discrete drum of a pneumatic mechanical spinning machine when a fiber pile is attached. Theoretical accuracy analyzes refine the determination of the volume of fibers flowing over the working surface. The analysis of forces was carried out taking into account the parameters of a discrete drum set. The interdependence of the forces acting on the fiber is illustrated graphically. The combing device should loosen the supplied belt onto the fiber complex, and ideally into the individual fibers and feed them evenly into the spinning rotor. In this case, it is desirable not to deteriorate the quality of the fibers and to maintain their degree of straightening, acquired at previous technological transitions. The arrangement of the fibers in width, with regard to density, is proportional to the density of the fibers in the beard.

KEY WORDS: uniformity, drum, fibers, headset, sampling, fibrous, uniformity, principle, technology, modernization, organ, quality, yarns, breakage.

1. INTRODUCTION

Production of high-quality competitive products based on the use of high, economical technologies is also the most important task of the textile industry. The quality of textiles in depends more on the uniformity, purity and strength of the yarn. They can be achieved by introducing and using modern equipment operating on more advanced technological principles[1].

Improvement of rotor spinning technology continues throughout the world to this day, which will lead to the creation of a new generations of spinning machines. Of no small importance is improvement of technology and modernization of individual units and workers organs of the machine, since the cost of modernization is many times lower than the cost for the purchase of new equipment. Our research is aimed at improving the process of sampling the fiber stream and forming yarn, which will improve the quality of the yarn, reduce breakage, increase the productivity of equipment and labor.

Elements with a needle set used in practice are shown in pic. 1. A short description of the individual parts of the headset is as follows. The sampling device should loosen the feed belt onto a set of fibers, and ideally into individual fibers and feed them evenly into the spinning box. At the same time, do not deteriorate the quality of fibers and maintain their degree of straightening, acquired at previous technological transitions [2].

Let us consider the stationary movements of the layer with the thickness of the fiber system h_b . Let us denote at each section the tension, density and velocity through the feeding zone. We assume that the layer moves along the arc with the linear speed of the drum teeth $v_b = R_b \omega_b$ where from ΔOAB we find

$$R_b = \sqrt{R_c^2 + l_c^2 + 2R_c l_c \cos(\alpha + \beta)}, \beta = \arcsin\left(\frac{l_c}{R_c} \sin \alpha\right),$$

R_b -drum radius, l_c -tooth height, α - angle between teeth and line OA , ω_b -radius and angular velocity of the drum. The equation of stationary motion of the layer according to the adopted model of the medium write in the form

$$L(T) \frac{dt}{d\varphi} - R_b \tau = 0$$

$$R_b q = m_1 v_b \omega_b R_b \quad (2)$$

Where φ - angle, arc-based AA ; $AL(T) = 1 + \varepsilon$, $\varepsilon = \frac{T}{ES_b}$; m_1 - linear mass of the product, $S_b = h_b L$, h_b - current layer thickness of the product, R - drum radius.

At the contact of the layer with the surface of the chamber, the dry friction law is fulfilled, where $\tau = f_b q$. Further, setting $T = ES_b \varepsilon$ for $\varepsilon^2 \approx 0$, write an equation for ε

$$\frac{d\varepsilon}{d\varphi} - f_b(1 + n_b^2)\varepsilon = -f_b n_b^2$$

Where $n_b = R_b \omega_b / a$, f_b - coefficient of friction between the drum and the chamber surface, the initial position of the angle φ is taken with the position of the product layer at the point. Решение уравнения (3), удовлетворяющее условию $\varepsilon = \varepsilon_2$ при $\varphi = 0$, имеет вид

$$\varepsilon = (\varepsilon_2 - \lambda_b^2) \exp\left(\frac{n_b^2 \varphi}{\lambda_b^2}\right) + \lambda_b^2 \quad (4)$$

Where $\lambda_b^2 = \frac{n_b^2}{1+n_b^2}$, ε_2 is determined by formula (4) at $\varphi = \varphi_k$

$$\varepsilon_2 = (\varepsilon_1 - \lambda^2) \exp\left(\frac{n^2 \varphi_k}{\lambda^2}\right) + \lambda^2 \quad (4-A)$$

Here, the layer thickness and density of the product are determined by the formulas

$$h = h_0 \frac{v_0}{R_b \omega_b} (1 + \varepsilon), \rho = \frac{\rho_0}{1 + \varepsilon} \approx \rho_0 (1 + \varepsilon) \quad (5)$$

We will assume that the maximum value of the layer density is reached at $\varphi = 0$. Then the function ε must be monotonic, and the increasing function reaches its maximum



a) b) c)

a - teeth with different diameters; b - teeth with different slopes; c - teeth with different heights;

Fig. 1. Proposed needle sampling drum options

value at $\varphi = \pi$. In this case, the deformation ε_2 and the density of the product at the entrance to the sampling zone satisfy the conditions

$$\varepsilon_2 > \lambda_b^2 = \frac{n_b^2}{1 + n_b^2},$$

$$\rho < \frac{\rho_0}{1 + n_b^2}$$

From the first inequality we obtain

$$\varepsilon_1 > \lambda^2 + (\lambda^2 - \lambda_b^2) \exp(-f \varphi_k n^2 / \lambda^2) \quad (6)$$

Thus, to ensure a monotonic decrease in the density of the product in the sampling zone, the deformation of the product when entering the clamping zone must satisfy the condition (6)

$$n = R\omega/a$$

In pic. 2. The curves of the distribution of deformation and density of the product in the sampling zone are presented in the calculations.

$$R_c = 0.0325m$$

$$\omega_b = 600c^{-1}, l_c = 0.005m, n_b = 0.22, \varepsilon_1 = 0.08$$

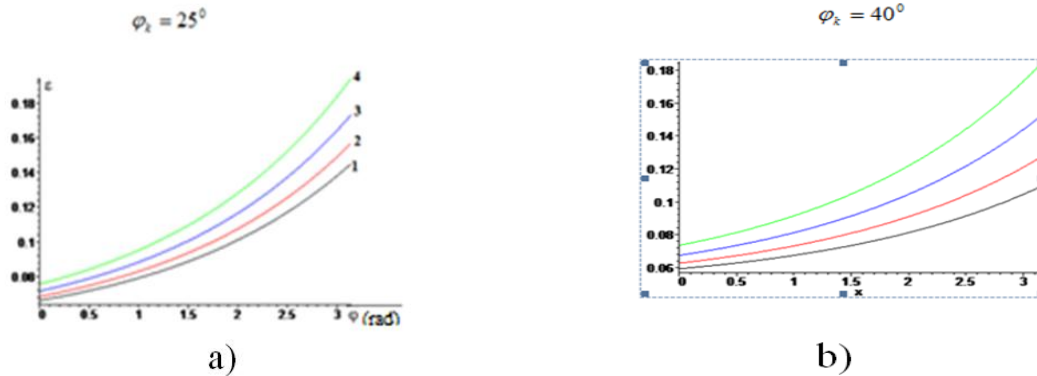

Fig. 2. Graphs of product deformation change along the arc of its contact with the chamber surface at different values of the ratio

$$n = \frac{R\omega}{a} : 1 - n = 0.1: 2 - n = 0.15: 3 - n = 0.2: 4 - n = 0,25:$$

Continuing the work of the discretizing ram, the teeth of which are filleted. (see figure 3.)

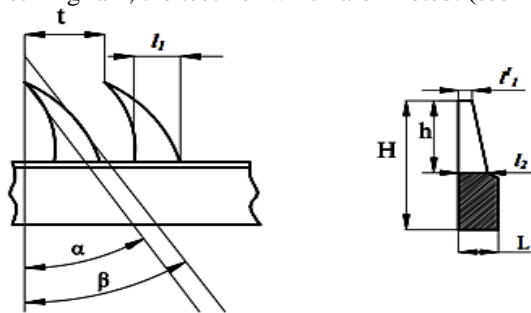

Fig 3. Construction of sawed sampling drum of spinning machine BD-350

II. MATERIALS AND METHODS

Formula for determining the volume of fibers flowing over 1mm²-surface.

Where area $S_0 = 1\text{mm}^2$ h - tooth height, t -tooth pitch, l_2 - thickness of the base of the tooth, l_1 - thickness of the base of the tooth. Narrowing each parameter, we explore the theoretical foundations of the sampling drum. $S = t \cdot h = 2.5 \cdot 1.8 = 4.5\text{mm}^2$

The gap between the two teeth of the sampling drum is chosen as the area and the movement of the fibers flowing along the surface of this area is discussed theoretically.

$$V = 0.1 \cdot h \left(1 - \frac{l_1 \cdot l_2}{3 \cdot L \cdot t}\right) S \quad (8)$$

Changes in fiber volume at tooth heights from $m - h_1$ to h_2

$$dV = \int_{h_1}^{h_2} 45 \cdot h \left(1 - \frac{l_1 \cdot l_2}{3 \cdot L \cdot t}\right) dh \Rightarrow \Delta V = 22.5 \cdot \left(1 - \frac{l_1 \cdot l_2}{3 \cdot L \cdot t}\right) \cdot (h_2^2 - h_1^2) \quad (9)$$

Fiber volume changes depending on the tooth pitch from t_1 to t_2

$$dV = \int_{t_1}^{t_2} 45 \cdot h \left(1 - \frac{l_1 \cdot l_2}{3 \cdot L \cdot t}\right) dt \Rightarrow \Delta V = \frac{h}{10} \left[\left(t_2 - \frac{l_1 \cdot l_2}{3 \cdot L \cdot t}\right) \ln|t_2| \right] - \left(t_1 - \frac{l_1 \cdot l_2}{3 \cdot L \cdot t}\right) \ln|t_1| \quad (10)$$

Changes in fiber volume depending on the size of the teeth from L_1 to L_2

$$dV = \int_{L_1}^{L_2} 0.1 \cdot h \left(1 - \frac{l_1 \cdot l_2}{3 \cdot L \cdot t}\right) dL \Rightarrow \Delta V = 45 \cdot h \left[\left(L_2 - \frac{l_1 \cdot l_2}{3 \cdot L \cdot t}\right) \ln|L_2| \right] - \left(L_1 - \frac{l_1 \cdot l_2}{3 \cdot L \cdot t}\right) \ln|L_1| \quad (11)$$

Changes in fiber volume depending on the basis of the width of the teeth from $l_{1.1}$ to $l_{1.2}$

$$dV = \int_{l_{1.1}}^{l_{1.2}} 45 \cdot h \left(1 - \frac{l_1 \cdot l_2}{3 \cdot L \cdot t}\right) dl_1 \Rightarrow \Delta V = 22.5 \cdot h \left(\Delta l_1 - \frac{l_2}{3 \cdot L \cdot t}\right) \cdot (l_{1.2}^2 - l_{1.1}^2) \quad (12)$$

Changes in fiber volume depending on the base of the teeth from $l_{2.1}$ to $l_{2.2}$

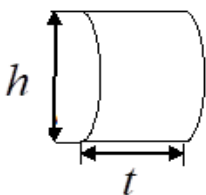

$$dV = \int_{l_{2,1}}^{l_{2,2}} 45 \cdot h \left(1 - \frac{l_1 \cdot l_2}{3 \cdot L \cdot t}\right) dl_2 \Rightarrow \Delta V = 22.5 \cdot h \left(\Delta l_2 - \frac{l_1}{3 \cdot L \cdot t}\right) \cdot (l_{2,2}^2 - l_{2,1}^2) \quad (13)$$

III. RESULTS AND DISCUSSION

To correctly solve the problems of increasing the efficiency of the sampling drum of rotor spinning machines and improving the quality of the web, it is first of all necessary to study in detail the forces acting on the fibrous tape during the sampling process, and to identify the possibilities of their most profitable use. Graphical dependence of the fiber volume of the surface of the width, height, height of the teeth of the sampling drum.

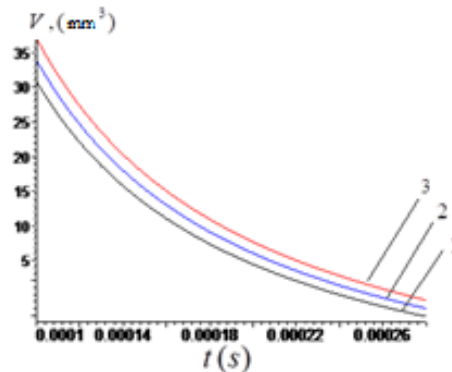

Fig. 4. Graphical dependence of the volume of fiber flow at the height of the tooth $S_0 = 1\text{mm}^2$ in between $t = 2.8 \cdot 10^{-4}$ times. Different height teeth

$$h_1 = 1.8\text{mm}, h_2 = 1.85\text{mm}, h_3 = 1.9\text{mm}$$

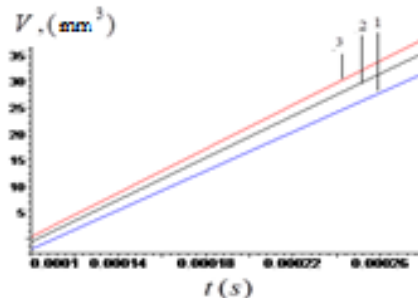

Fig. 5. Graphical dependence of the volume $S_0 = 1\text{mm}^2$ flow of fibers per tooth steps in the interval $t = 2.8 \cdot 10^{-4}$ times. Different tooth pitches: $t_1 = 2.5\text{mm}, t_2 = 2.5\text{mm}, t_3 = 2.7\text{mm}$.

Formula for determining fiber entanglement on an area of 1mm^2

$$K = \cos^2 \alpha \cdot e^{\left[\frac{\mu \cdot l}{\pi} \left(\frac{1}{L} + \frac{1}{t}\right)\right]} \quad (14)$$

μ - coefficient of friction between fibers and feeding table,

L - thickness of teeth, t -step of teeth, l - fiber length, α - oblique charcoal teeth of a sampled drum. Knowing these parameters, it can be written in the following order.

$$K = (\cos(\alpha))^2 \cdot e^{\left(\mu \cdot l \cdot \frac{t+L}{\pi}\right)} \quad (15)$$

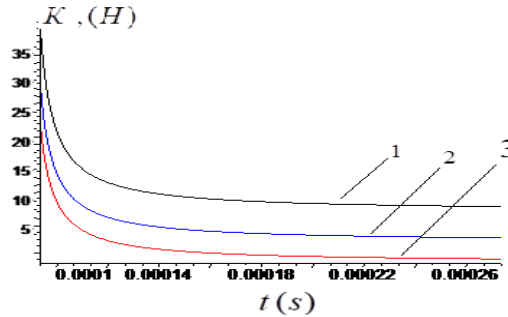

Fig. 6. Graphical dependence of the angle of inclination of the force of engagement of the teeth: Different type of angle of inclination $\alpha_1 = 54^\circ, \alpha_2 = 58^\circ, \alpha_3 = 62^\circ$.

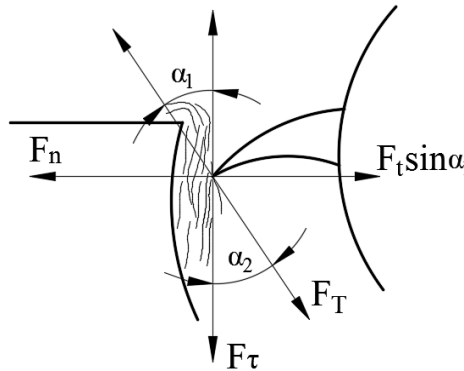

Fig. 7. Analysis of the work of the sampling drum.

Where F_T - tangential force, F_τ - tangential force, F_N - нормальная сила, see angles are mutually equal, namely: $\alpha_1 = \alpha_2$.

Successful operation of rotor spinning machines largely depends on the correct sampling drum set selected. The headset must ensure long-term and uninterrupted operation of sampling zones with the required sampling quality and the admissible evenness of the fibrous tape [3].

At the moment, the impulse force m_1 is the mass of the fibers during the gap from $\Delta\tau$ is defined by the following formulas.

$$F_t \Delta\tau = m_t (v_2 - v_1) \quad (16)$$

Where v_1 - sampling drum speed, v_2 - speed of the sampling drum along with the fibers.

The movement of the total fibers for the interval Δx depends on the short time $\Delta\tau$ and it is equal to

$$\Delta X = \Delta\tau v_{aver} \quad (17)$$

Determine the total mass between the volume ΔV of the fibers.

$$m_{gen} = m_t n \quad (18)$$

Where: m_t - the mass of one fiber, n - is the number of fibers. Under the condition, the average speed must be known and it is equal to

$$v_{cp} = \frac{v_1 + v_2}{2} \quad (19)$$

The volume of teeth V between the phases of the sampling drum is determined from the capacity of the fibers.

Determine the volume changes depending on the surface areas of the teeth of the sampling drum.

$$m_t = 0.1 \cdot h \cdot S \cdot \left(1 - \frac{l_1 \cdot l_2}{3 \cdot L}\right) \delta \quad (20)$$

The values of equation (19) are substituted by equation (20) and we obtain.

$$F_t \cdot \Delta\tau = 0.1 \cdot h \cdot S \cdot \delta \left(1 - \frac{l_1 \cdot l_2}{3 \cdot L}\right) (v_2 - v_1) \quad (21)$$

$\Delta\tau$ - in this forum equals

$$\Delta\tau = \frac{\Delta X}{v_{cp}} = \frac{2 \cdot \Delta X}{v_1 + v_2} \quad (22)$$

The values of equation (22) are substituted by equation (21) and we obtain the following equation.

$$F_t = 0.1 \cdot h \cdot S \cdot \delta \left(1 - \frac{l_1 \cdot l_2}{3 \cdot L}\right) (v_2^2 - v_1^2) / 2 \cdot \Delta X \quad (23)$$

This is a formula that determines the parameter dependence of the tangential or tangential force on the parallel motion of the fiber volume.

h - height of teeth, S -tooth pitch, δ - thickness of base teeth, L -thickness of teeth, l_1 - width of base of teeth.

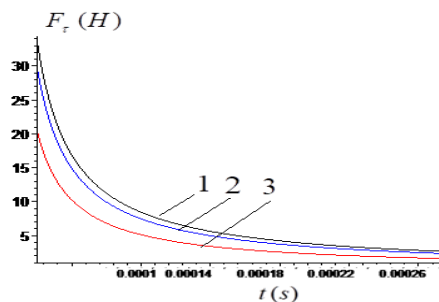

Fig. 8. Graphical dependence of the tangential force of the sampling drum on its linear velocity on an area of 1mm²

Different linear speed of sampling drum

$$1) \frac{352m}{c} \quad 2) \frac{379m}{c} \quad 3) \frac{406m}{c}$$

IV. CONCLUSION

To design the parameters of the sampling drum headsets, it is necessary to take into account the portion of the headset's retention capacity per unit fiber capacity. The influence of each geometric parameter of the typeface on the sampling process is analyzed and built for their graphics.

REFERENCES

1. V.K. Kryuchkova, L.N. Dergunova, S.S. Maksudov et al. Problem in increasing the competitiveness of yarn and fabrics (review). Tashkent, 1993].
2. Ripka I. Theoretical study of some basic phenomena. - Collection of reports on spindleless spinning., Prague, 2009, p. 1-36.
3. Baturin Yu.A. The load on the set of scratching surfaces and the percentage of fiber transition from one surface to another. "Technology of the textile industry" 1964. №4
4. Shepherd J.M. A theoretical investigation of some factors affecting end breakage rate in open-end spinning devices. Berlin, Springer Verlag, 2018, s.301-309.
5. Peirce F.T. The plasticity of cotton and other materials. Symposium SIRTEC, Paris, 2014, s.56-65.